

High-frequency Relay

G6Z

Miniature 2.6-GHz-Band, SPDT, High-frequency Relay

- Superior high-frequency characteristics include an isolation of 30 dB min., 60-65 dB isolation at 900 MHz, insertion loss of 0.5 dB max., and V.SWR of 1.5 max. at 2.6 GHz.
- Triplate micro stripline technology assures superior high-frequency characteristics.
- Miniature dimensions of 20 × 8.6 × 8.9 mm (L × W × H).
- Available models include single-coil latching (200 mW), dual coil latching (360 mW), and models with reverse contact arrangement.
- Series includes versions with an E-shape terminal structure, and models with a Y-shape terminal structure, allowing greater freedom with PCB design.
- Models with 75-Ω impedance and models with 50-Ω impedance are also available.
- Surface mount relays available in tube packaging or tape-and-reel packaging.

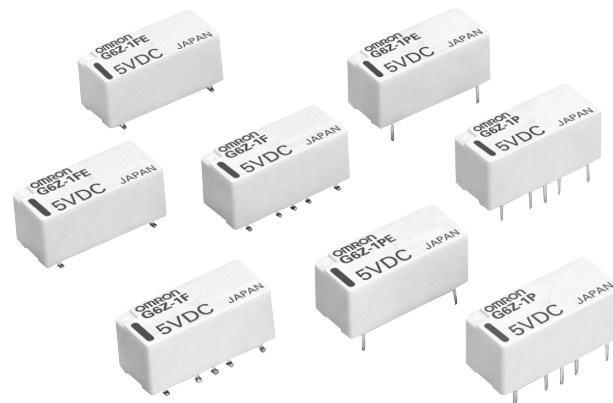

Ordering Information

■ Model Number Legend:

G6Z-□-□□□-□□-DC□

1 2 3 4 5 6 7

1. Relay Function

None: Non-latching
 U: Single coil latching
 K: Dual coil latching

2. Contact Form

1: SPDT

3. Terminal Shape

F: Surface mount terminals
 P: PCB through-hole terminals

4. Terminal Structure

None: Y-shape terminal
 E: E-shape terminal

5. Characteristic Impedance

None: 75 Ω
 A: 50 Ω

6. Contact Arrangement

None: Standard contact arrangement
 R: Reverse contact arrangement

7. Rated Coil Voltage

3, 4.5, 5, 9, 12, 24

■ Standard Models with PCB Through-hole Terminals

Classification	Structure	Contact form	Terminal arrangement	Characteristic impedance	Rated coil voltage	Model
Non-latching	Fully sealed	SPDT	E-shape	75 Ω	3, 4.5, 5, 9, 12, and 24 VDC	G6Z-1PE
				50 Ω	3, 4.5, 5, 9, 12, and 24 VDC	G6Z-1PE-A
			Y-shape	75 Ω	3, 4.5, 5, 9, 12, and 24 VDC	G6Z-1P
				50 Ω	3, 4.5, 5, 9, 12, and 24 VDC	G6Z-1P-A
Single coil latching			E-shape	75 Ω	3, 4.5, 5, 9, 12, and 24 VDC	G6ZU-1PE
				50 Ω	3, 4.5, 5, 9, 12, and 24 VDC	G6ZU-1PE-A
			Y-shape	75 Ω	3, 4.5, 5, 9, 12, and 24 VDC	G6ZU-1P
				50 Ω	3, 4.5, 5, 9, 12, and 24 VDC	G6ZU-1P-A
Dual coil latching	E-shape	75 Ω	3, 4.5, 5, 9, 12, and 24 VDC	G6ZK-1PE		
		50 Ω	3, 4.5, 5, 9, 12, and 24 VDC	G6ZK-1PE-A		
	Y-shape	75 Ω	3, 4.5, 5, 9, 12, and 24 VDC	G6ZK-1P		
		50 Ω	3, 4.5, 5, 9, 12, and 24 VDC	G6ZK-1P-A		

■ Standard Models with Surface-mounting Terminals

Classification	Structure	Contact form	Terminal arrangement	Characteristic impedance	Rated coil voltage	Model
Non-latching	Fully sealed	SPDT	E-shape	75 Ω	3, 4.5, 5, 9, 12, and 24 VDC	G6Z-1FE
				50 Ω	3, 4.5, 5, 9, 12, and 24 VDC	G6Z-1FE-A
			Y-shape	75 Ω	3, 4.5, 5, 9, 12, and 24 VDC	G6Z-1F
				50 Ω	3, 4.5, 5, 9, 12, and 24 VDC	G6Z-1F-A
Single coil latching			E-shape	75 Ω	3, 4.5, 5, 9, 12, and 24 VDC	G6ZU-1FE
				50 Ω	3, 4.5, 5, 9, 12, and 24 VDC	G6ZU-1FE-A
			Y-shape	75 Ω	3, 4.5, 5, 9, 12, and 24 VDC	G6ZU-1F
				50 Ω	3, 4.5, 5, 9, 12, and 24 VDC	G6ZU-1F-A
Dual coil latching	E-shape	75 Ω	3, 4.5, 5, 9, 12, and 24 VDC	G6ZK-1FE		
		50 Ω	3, 4.5, 5, 9, 12, and 24 VDC	G6ZK-1FE-A		
	Y-shape	75 Ω	3, 4.5, 5, 9, 12, and 24 VDC	G6ZK-1F		
		50 Ω	3, 4.5, 5, 9, 12, and 24 VDC	G6ZK-1F-A		

Note: When ordering tape and reel packaging (surface-mount models), add “-TR” to the model number, (example: G6Z-1FE“TR”-DC12) “-TR” does not appear on the relay itself.

Application Examples

These Relays can be used for switching signals in media equipment.

- **Wire communications:**

Cable TV (STB and broadcasting infrastructure), cable modems, and VRS (video response systems)

- **Wireless communications:**

Transceivers, ham radios, car telephones, ETC, ITS, high-level TV, satellite broadcasting, text multiplex broadcasting, pay TV, mobile phone stations, TV broadcasting facilities, and community antenna systems

- **Public equipment:**

TVs, TV games, satellite radio units, car navigation systems

- **Industrial equipment:**

Measuring equipment, test equipment, and multiplex transmission devices

Specifications

■ Contact Ratings

Load type	Resistive load
Rated load	10 mA at 30 VAC; 10 mA at 30 VDC; 10 W at 900 MHz (See note)
Rated carry current	0.5 A
Max. switching voltage	30 VAC, 30 VDC
Max. switching current	0.5 A

Note: This value is for an impedance of 50 Ω or 75 Ω with a V.SWR of 1.2 max.

■ High-frequency Characteristics

Frequency		900 MHz				2.6 GHz			
		Through hole		Surface mount		Through hole		Surface mount	
Terminal type		Through hole		Surface mount		Through hole		Surface mount	
Terminal structure		E-shape	Y-shape	E-shape	Y-shape	E-shape	Y-shape	E-shape	Y-shape
Isolation	75 Ω	65 dB min.		60 dB min.		35 dB min.	45 dB min.	30 dB min.	40 dB min.
	50 Ω	60 dB min.							
Insertion loss (not including substrate loss)	75 Ω	0.2 dB max.				0.5 dB max.			
	50 Ω	0.1 dB max.				0.3 dB max.			
V.SWR	75 Ω	1.2 max.				1.5 max.			
	50 Ω	1.1 max.				1.3 max.			
Return loss	75 Ω	20.8 dB max.				14.0 dB max.			
	50 Ω	26.4 dB max.				17.7 dB max.			
Maximum carry power		10 W (See note 2)							
Maximum switching power		10 W (See note 2)							

Note: 1. The above values are initial values.

2. These values are for an impedance of 50 Ω or 75 Ω with a V.SWR of 1.2 max.

■ Coil Ratings

The operating characteristics are measured at a coil temperature of 23° C.

Non-latching, Standard and Reverse-contact Models

Rated voltage (VDC)	Rated current (mA)	Coil resistance (Ω ±10%)	Must operate voltage (VDC)	Must dropout voltage (VDC)	Maximum voltage (VDC) at 70° C max.	Power consumption (mW)
3	66.7	45	2.25	0.3	4.5	Approx. 200
4.5	44.4	101.3	3.375	0.45	6.75	
5	40.0	125	3.75	0.5	7.5	
9	22.2	405	6.75	0.9	13.5	
12	16.7	720.4	9	1.2	18	
24	8.3	2880.1	18	2.4	36	

Single Coil Latching Models G6ZU-1P(E), G6ZU-1F(E)

Rated voltage (VDC)	Rated current (mA)	Coil resistance (Ω ±10%)	Must set voltage (VDC)	Must reset voltage (VDC)	Maximum voltage (VDC) at 70° C max.	Power consumption (mW)
3	66.7	45	2.25	2.25	150% of rated voltage	Approx. 200
4.5	44.4	101.3	3.375	3.375		
5	40.0	125	3.75	03.75		
9	22.2	405	6.75	6.75		
12	16.7	720.4	9	9		
24	8.3	2880.1	18	18		

Dual Coil Latching Models G6ZK-1P(E), G6ZK-1F(E)

Rated voltage (VDC)	Rated current (mA)	Coil resistance (Ω , $\pm 10\%$)	Must set voltage (VDC)	Must reset voltage (VDC)	Maximum voltage (VDC) at 70°C max.	Power consumption (mW)
3	120	25	2.25	2.25	150% of rated voltage	Approx. 360
4.5	80	56.2	3.375	3.375		
5	72	69.4	3.75	03.75		
9	40	224.9	6.75	6.75		
12	30	400	9	9		
24	15	1599.9	18	18		

- Note:**
1. The rated current and coil resistance are measured at a coil temperature of 23°C with a tolerance of $\pm 10\%$.
 2. The operating characteristics are measured at a coil temperature of 23°C.
 3. The maximum voltage is the highest voltage that can be imposed on the relay coil instantaneously.

Characteristics

Item	Non-latching models		Single coil latching models	Dual coil latching models
	G6Z-1P(E), G6Z-1F(E)		G6ZU-1P(E), G6ZU-1F(E)	G6ZK-1P(E), G6ZK-1F(E)
Contact resistance (See note 2)	100 mΩ max.			
Operating (set) time (See note 3)	10 ms max. (approx. 3.5 ms)		10 ms max. (approx. 2.5 ms)	
Release (reset) time (See note 3)	10 ms max. (approx 2.5 ms)			
Set/reset time	---		12 ms	
Insulation resistance (See note 4)	100 MΩ min. (at 500 VDC)			
Dielectric strength	Coil and contacts	1,000 VAC, 50/60 Hz for 1 min.		
	Coil and ground, contacts and ground	500 VAC, 50/60 Hz for 1 min.		
	Contacts of same polarity	500 VAC, 50/60 Hz for 1 min.		
Vibration resistance	Mechanical durability	10 to 55 to 10 Hz, 0.75-mm single amplitude (1.5-mm double amplitude)		
	Malfunction durability	10 to 55 to 10 Hz, 0.75-mm single amplitude (1.5-mm double amplitude)		
Shock resistance	Mechanical durability	1,000 m/s ²		
	Malfunction durability	500 m/s ²		
Service life	Mechanical	1,000,000 operations min. (at 36,000 operations/hour)		
	Electrical	300,000 operations min. (30 VAC, 10 mA/30 VDC, 10 mA), 100,000 operations min. (900 MHz, 10 W) at a switching frequency of 1,800 operations/hour		
Ambient temperature	Operating: -40° C to 70° C (-40° F to 158° F) (with no icing or condensation)			
Ambient humidity	Operating: 5% to 85% RH			
Weight	Approx. 2.8 g			

Note: 1. The above values are initial values.

2. The contact resistance was measured with 10 mA at 1 VDC with a voltage drop method.

3. Values in parentheses are actual values.

4. The insulation resistance was measured with a 500-VDC megohmmeter applied to the same parts as those used for checking the dielectric strength.

Engineering Data

Ambient Temperature vs. Maximum Voltage

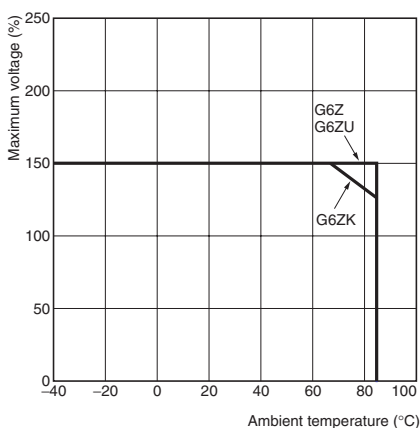

Ambient Temperature vs. Must Operate or Must Release Voltage

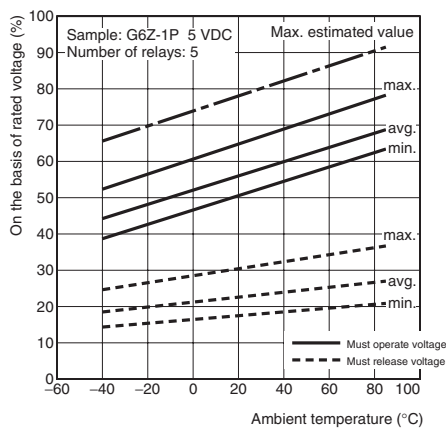

Shock Malfunction

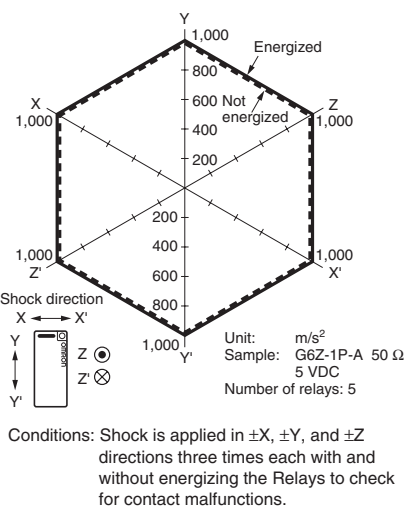

Electrical Endurance (with Must Operate and Must Release Voltage)

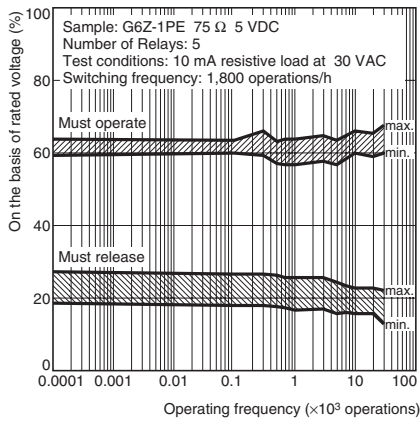

Electrical Endurance (with Must Operate and Must Release Voltage)

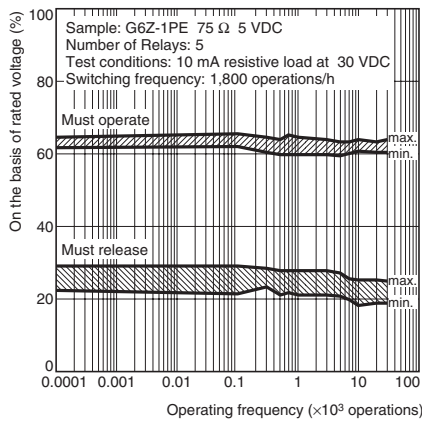

Electrical Endurance (Contact Resistance)

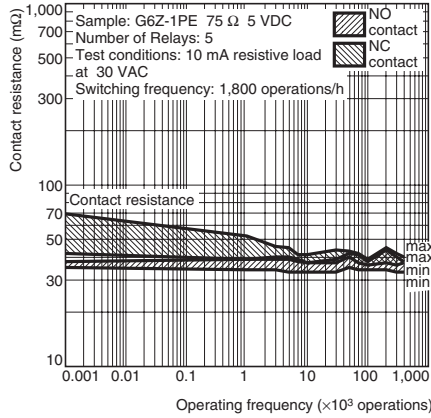

Electrical Endurance (Contact Resistance)

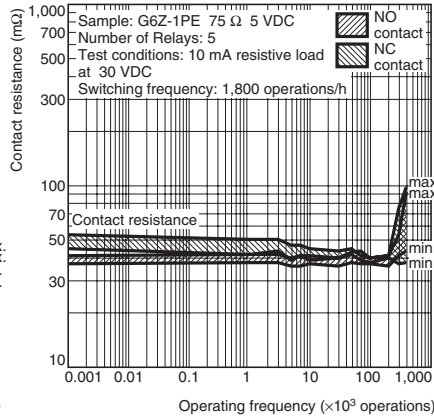

External Magnetic Interference

(Average value)

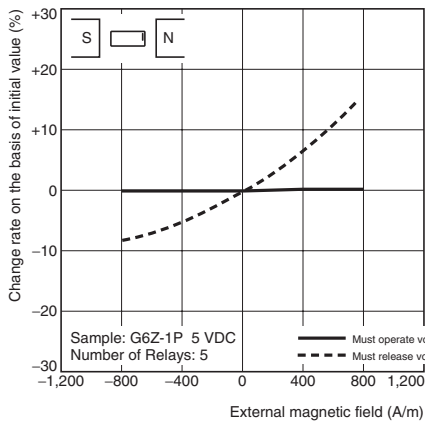

(Average value)

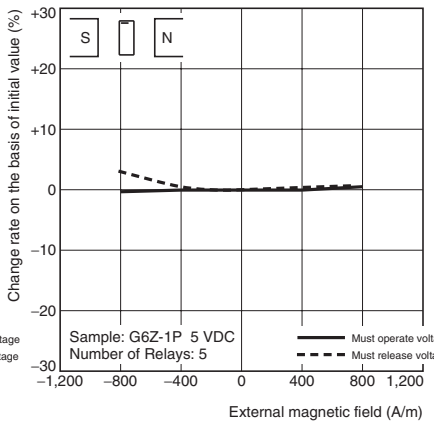

(Average value)

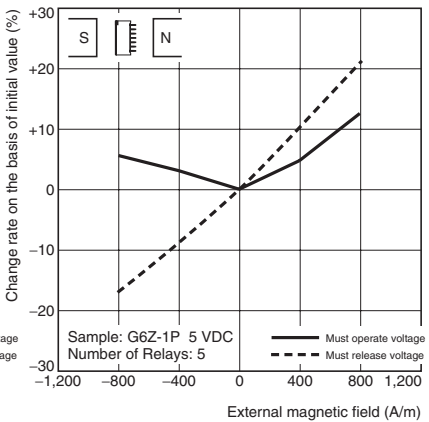

High-frequency Characteristics at 75 Ω (Isolation)

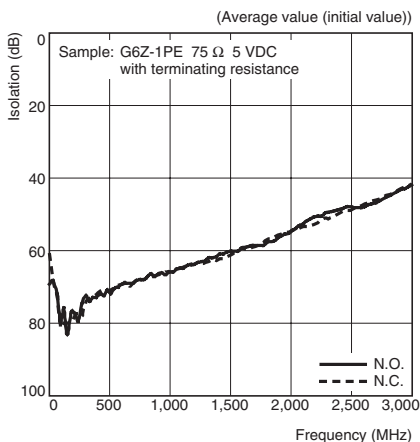

High-frequency Characteristics at 75 Ω (Insertion Loss)

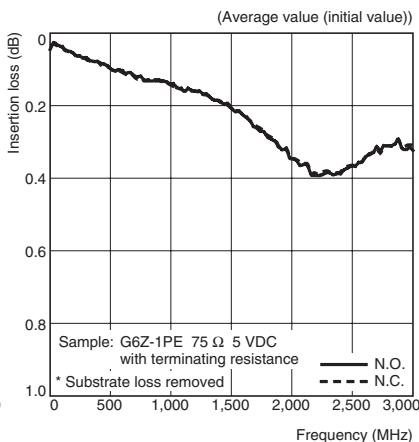

High-frequency Characteristics at 75 Ω (Return Loss, V.SWR)

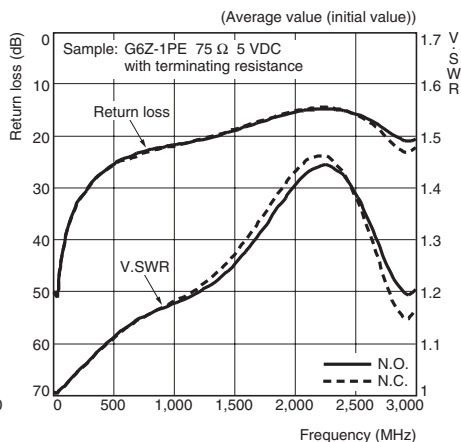

High-frequency Characteristics at 50 Ω (Isolation)

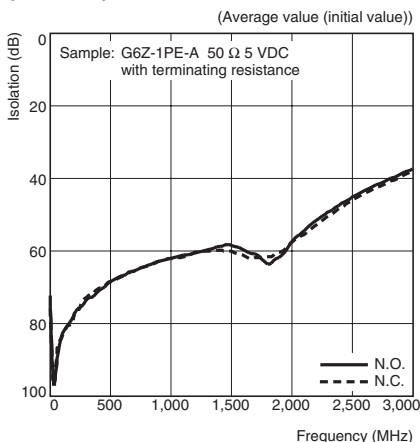

High-frequency Characteristics at 50 Ω (Insertion Loss)

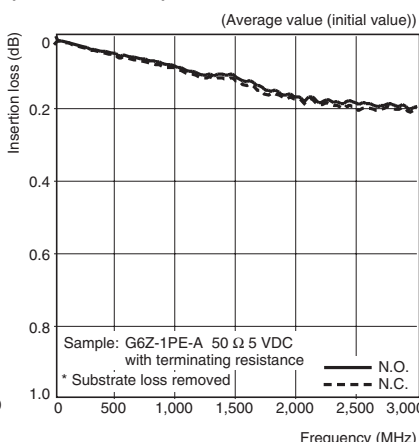

High-frequency Characteristics at 50 Ω (Return Loss, V.SWR)

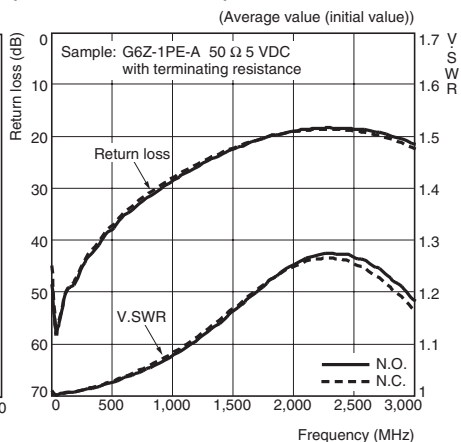

Must Operate and Must Release Time Distribution (See note.)

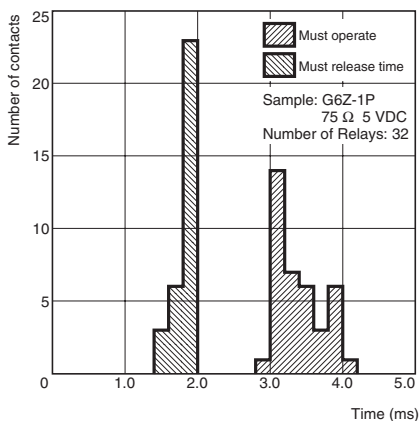

Must Operate and Must Release Bounce Time Distribution (See note.)

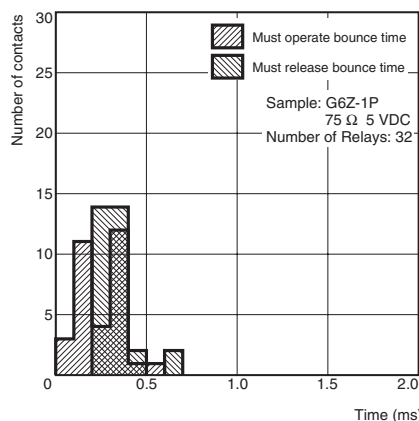

Note: The tests were conducted at an ambient temperature of 23°C.

Dimensions

Unit: mm

PCB Through-hole Terminal Types

G6Z-1PE
G6Z-1PE-R
G6ZU-1PE

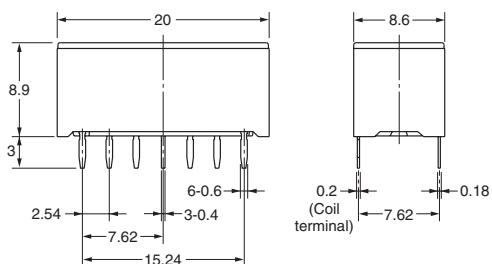
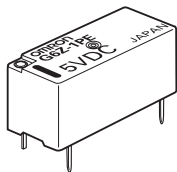

Mounting Dimensions (Bottom View)
Tolerance: ± 0.1 mm

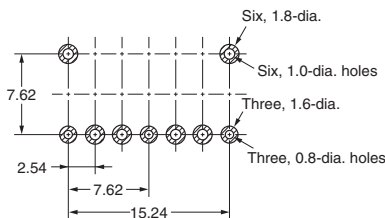

Terminal Arrangement/Internal Connections (Bottom View)

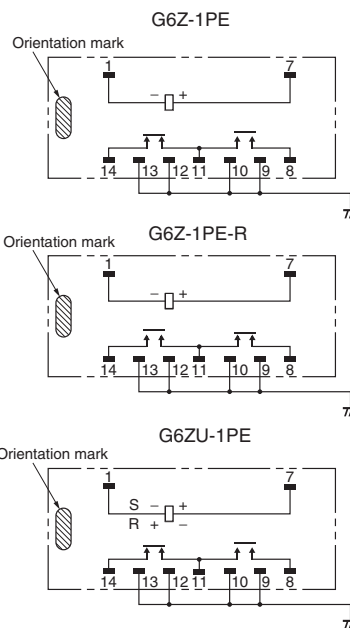

Note: Each value has a tolerance of ± 0.3 mm.

G6Z-1PE-A
G6ZU-1PE-A

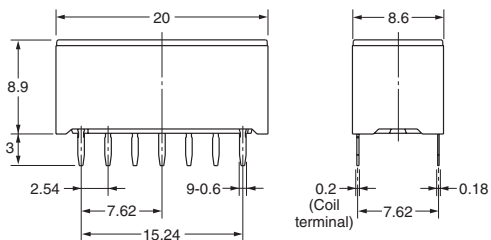
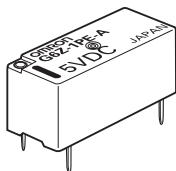

Mounting Dimensions (Bottom View)
Tolerance: ± 0.1 mm

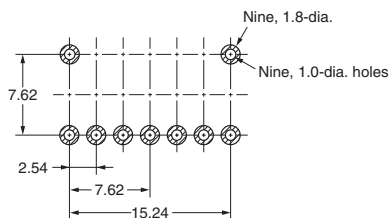

Terminal Arrangement/Internal Connections (Bottom View)

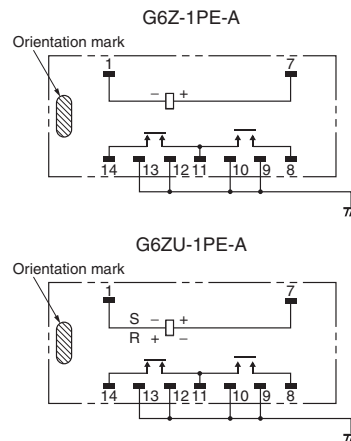

Note: Each value has a tolerance of ± 0.3 mm.

**G6Z-1P
G6ZU-1P**

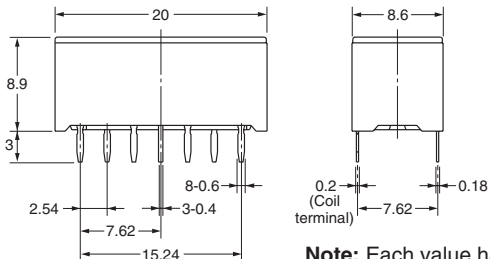
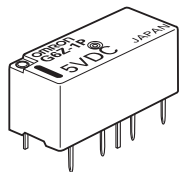

Note: Each value has a tolerance of ± 0.3 mm.

Mounting Dimensions (Bottom View)
Tolerance: ± 0.1 mm

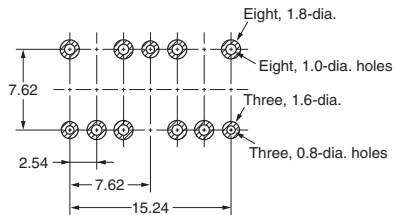

Terminal Arrangement/Internal Connections (Bottom View)

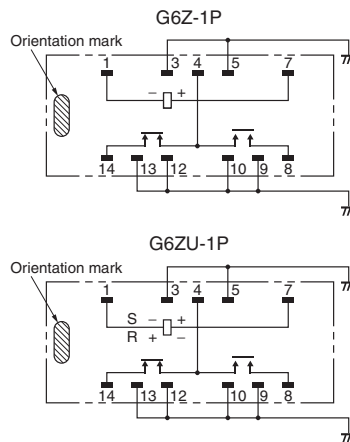

**G6Z-1P-A
G6ZU-1P-A**

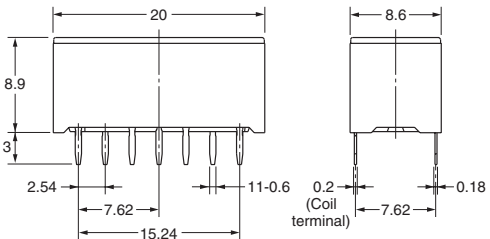
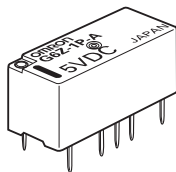

Note: Each value has a tolerance of ± 0.3 mm.

Mounting Dimensions (Bottom View)
Tolerance: ± 0.1 mm

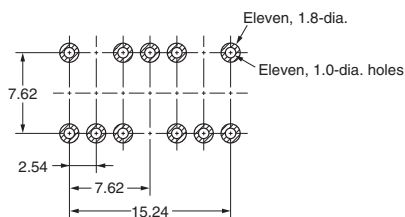

Terminal Arrangement/Internal Connections (Bottom View)

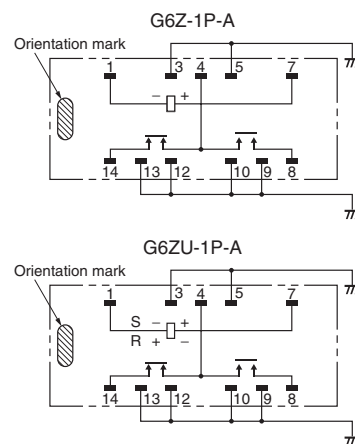

G6ZK-1PE

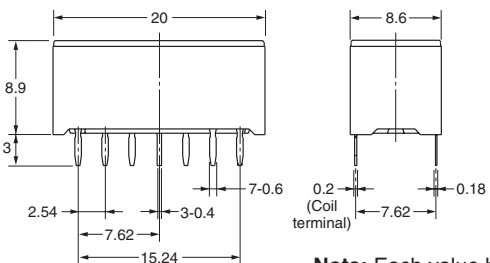
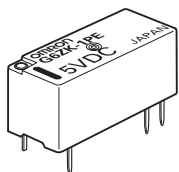

Note: Each value has a tolerance of ± 0.3 mm.

Mounting Dimensions (Bottom View)
Tolerance: ± 0.1 mm

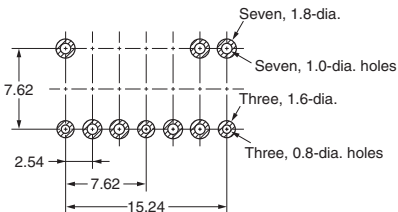

Terminal Arrangement/Internal Connections (Bottom View)

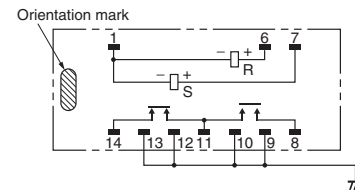

G6ZK-1PE-A

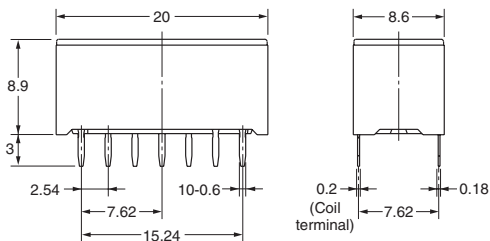
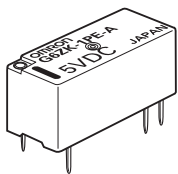

Mounting Dimensions (Bottom View)

Tolerance: ± 0.1 mm

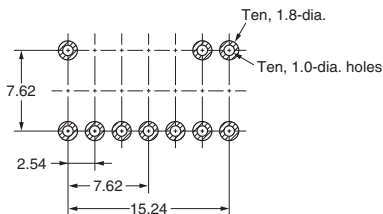

Terminal Arrangement/Internal Connections (Bottom View)

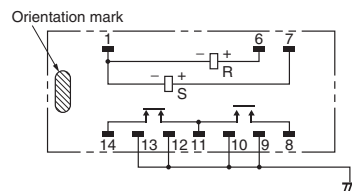

Note: Each value has a tolerance of ± 0.3 mm.

G6ZK-1P

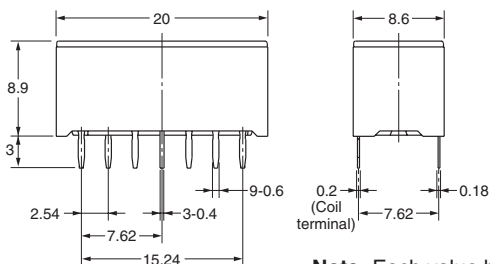
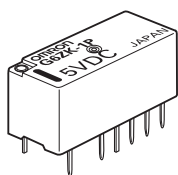

Mounting Dimensions (Bottom View)

Tolerance: ± 0.1 mm

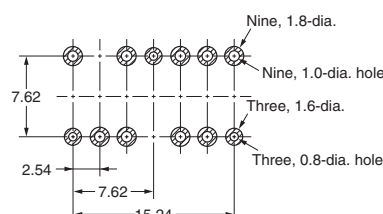

Terminal Arrangement/Internal Connections (Bottom View)

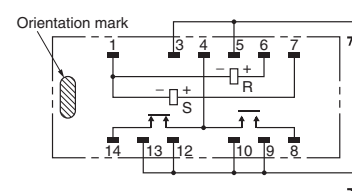

Note: Each value has a tolerance of ± 0.3 mm.

G6ZK-1P-A

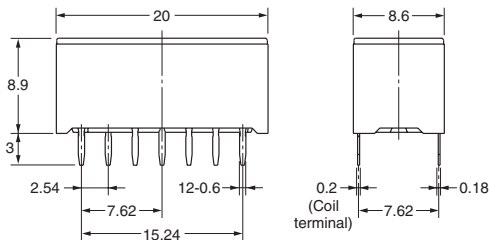
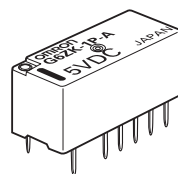

Mounting Dimensions (Bottom View)

Tolerance: ± 0.1 mm

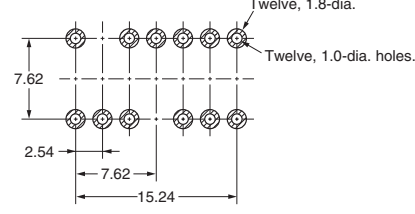

Terminal Arrangement/Internal Connections (Bottom View)

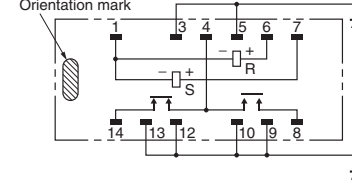

Note: Each value has a tolerance of ± 0.3 mm.

■ Surface Mount Terminal Types

G6Z-1FE
G6ZU-1FE

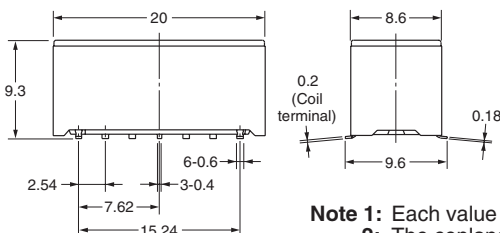
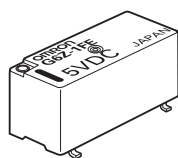

Mounting Dimensions (Top View)
Tolerance: ± 0.1 mm

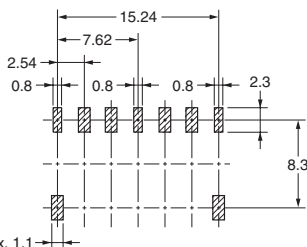

Terminal Arrangement/Internal Connections (Top View)

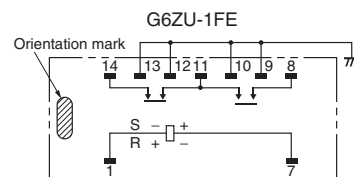
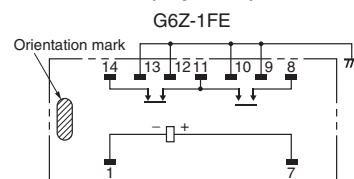

Note 1: Each value has a tolerance of ± 0.3 mm.
2: The coplanarity of the terminals is 0.1 mm max.

G6Z-1FE-A
G6ZU-1FE-A

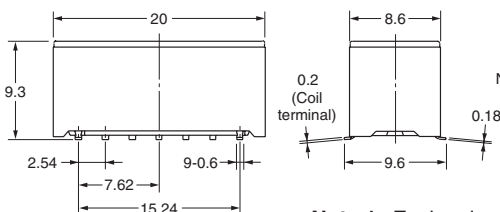
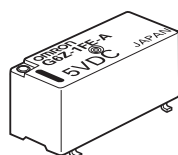

Mounting Dimensions (Top View)
Tolerance: ± 0.1 mm

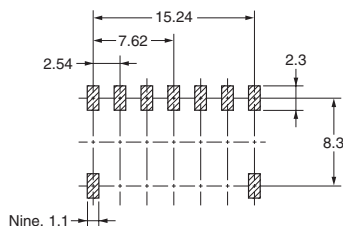

Terminal Arrangement/Internal Connections (Top View)

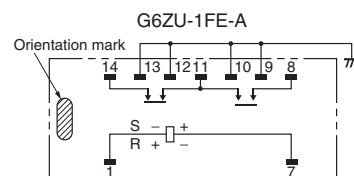
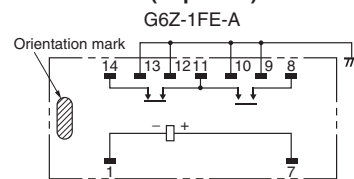

Note 1: Each value has a tolerance of ± 0.3 mm.
2: The coplanarity of the terminals is 0.1 mm max.

G6Z-1F
G6ZU-1F

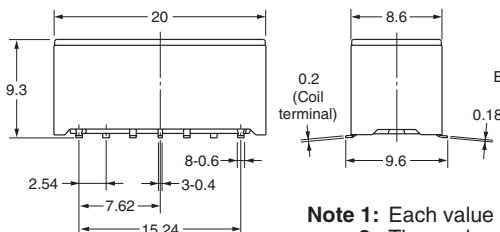
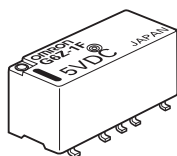

Mounting Dimensions (Top View)
Tolerance: ± 0.1 mm

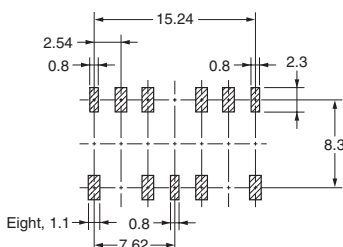

Terminal Arrangement/Internal Connections (Top View)

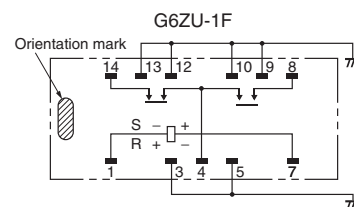
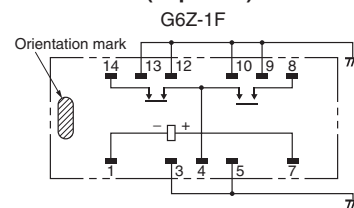

Note 1: Each value has a tolerance of ± 0.3 mm.
2: The coplanarity of the terminals is 0.1 mm max.

**G6Z-1F-A
G6ZU-1F-A**

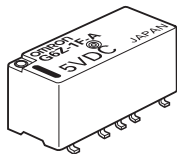

Mounting Dimensions (Top View)

Tolerance: ± 0.1 mm

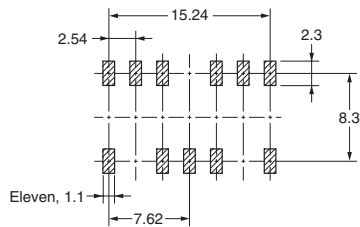
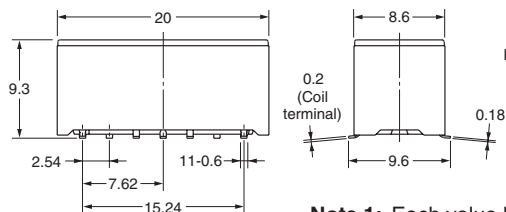

Note 1: Each value has a tolerance of ± 0.3 mm.
Note 2: The coplanarity of the terminals is 0.1 mm max.

Terminal Arrangement/Internal Connections (Top View)

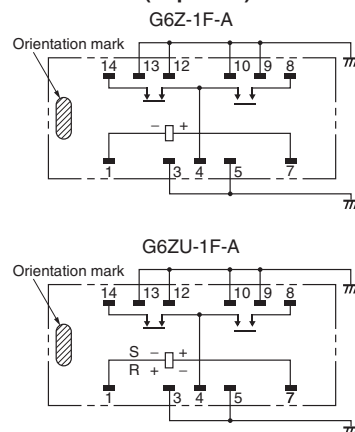

G6ZK-1FE

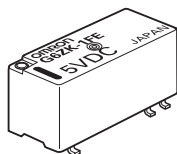

Mounting Dimensions (Top View)

Tolerance: ± 0.1 mm

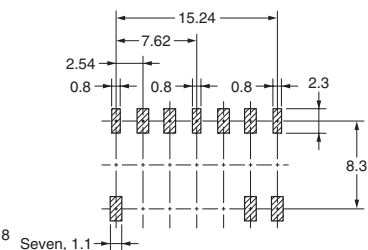
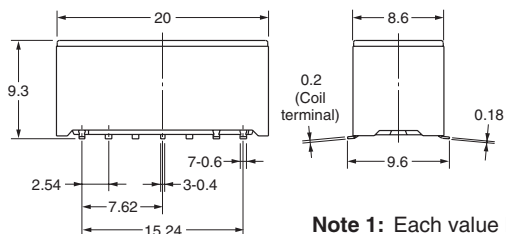

Note 1: Each value has a tolerance of ± 0.3 mm.
Note 2: The coplanarity of the terminals is 0.1 mm max.

Terminal Arrangement/Internal Connections (Top View)

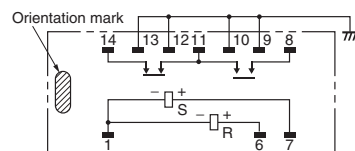

G6ZK-1FE-A

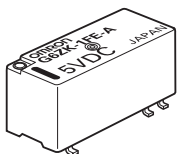

Mounting Dimensions (Top View)

Tolerance: ± 0.1 mm

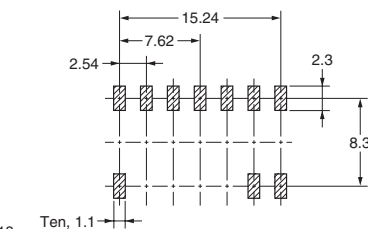
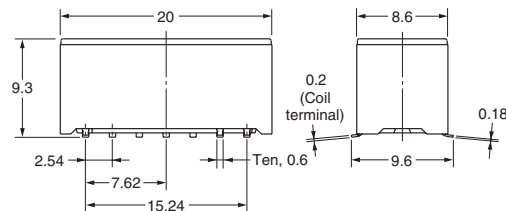

Note 1: Each value has a tolerance of ± 0.3 mm.
Note 2: The coplanarity of the terminals is 0.1 mm max.

Terminal Arrangement/Internal Connections (Top View)

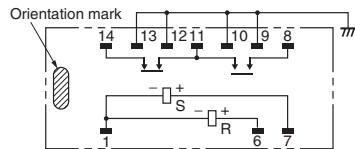

G6ZK-1F

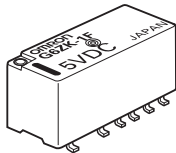

Mounting Dimensions (Top View)
Tolerance: ± 0.1 mm

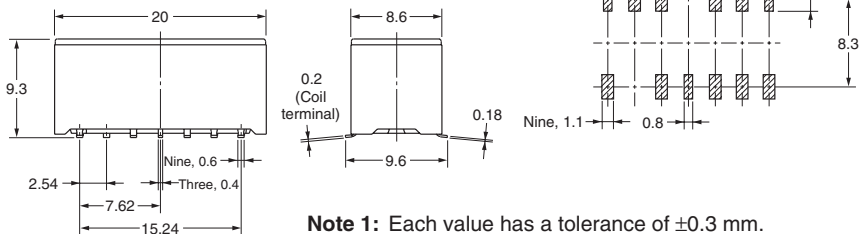

Note 1: Each value has a tolerance of ± 0.3 mm.
Note 2: The coplanarity of the terminals is 0.1 mm max.

Terminal Arrangement/Internal Connections (Top View)

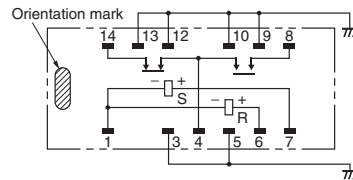

G6ZK-1F-A

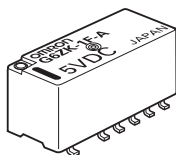

Mounting Dimensions (Top View)
Tolerance: ± 0.1 mm

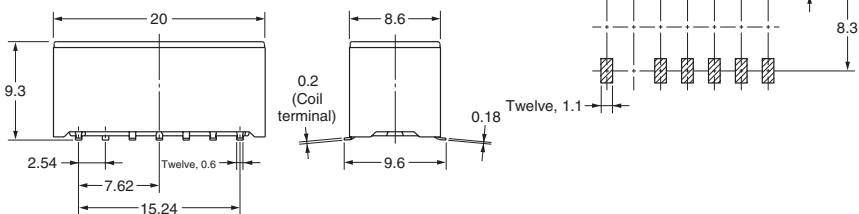

Note 1: Each value has a tolerance of ± 0.3 mm.
Note 2: The coplanarity of the terminals is 0.1 mm max.

Terminal Arrangement/Internal Connections (Top View)

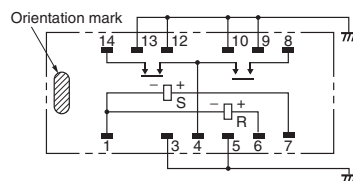

Tube Packaging and Tape and Reel Packaging

■ Tube Packaging

Relays in tube packaging are arranged so that the orientation mark of each Relay is on the left side.

Be sure not to make mistakes in Relay orientation when mounting the Relay to the PCB.

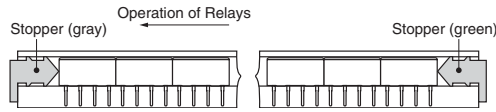

Tube length: 530 mm (stopper not included)
No. of Relays per tube: 25

■ Tape and Reel Packaging (Surface mount Terminal Models)

When ordering Relays in tape packing, add the prefix “-TR” to the model number, otherwise the Relays in stick packing will be provided.

Relays per Reel: 300

Direction of Relay Insertion

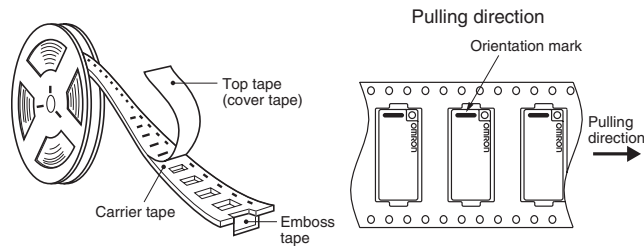

Reel Dimensions

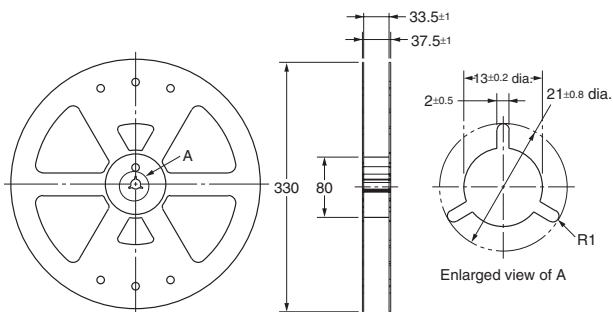

Carrier Tape Dimensions

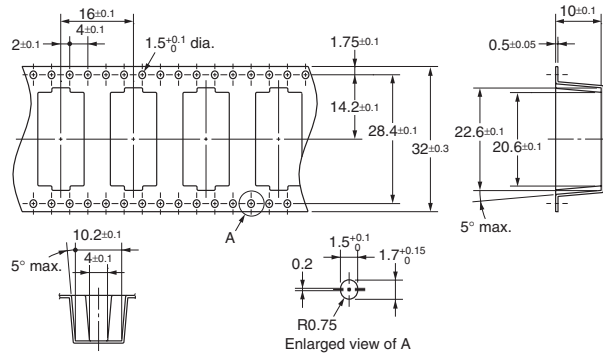

Note: The radius of the unmarked corner is 0.3 mm.

Recommended Soldering Method

Temperature Conditions for IRS Method

When using reflow soldering, ensure that the Relay terminals and the top of the case stay below the following curve. Check that these conditions are actually satisfied before soldering the terminals.

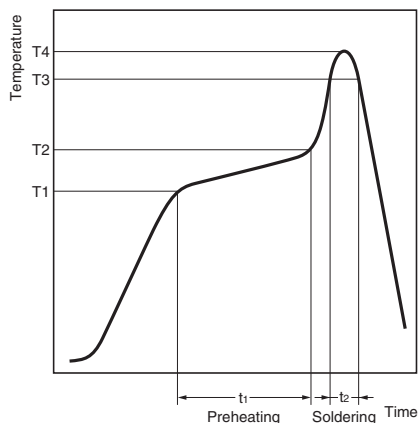

Measured part	Preheating (T1 →T2, t1)	Soldering (T3, t2)	Maximum peak (T4)
Terminals	150 →180° C, 120 s max.	230° C min, 30 s max.	250° C max.
Top of case	---	---	255° C max.

Do not quench the terminals after mounting. Clean the Relay using alcohol or water no hotter than 40° C max.

The thickness of cream solder to be applied should be between 150 and 200 μm on OMRON's recommended PCB pattern.

Correct Soldering

Incorrect Soldering

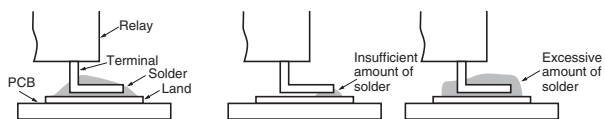

Check the soldering in the actual mounting conditions before use.

Safety Precautions

■ Precautions for Correct Use

Please observe the following precautions to prevent failure to operate, malfunction, or undesirable effect on product performance.

High-frequency Characteristics Measurement Method and Measurement Substrate

High-frequency characteristics for the G6Z are measured in the way shown below. Consult your OMRON representative for details on 50-Ω models.

Measurement Method for 75-Ω Models

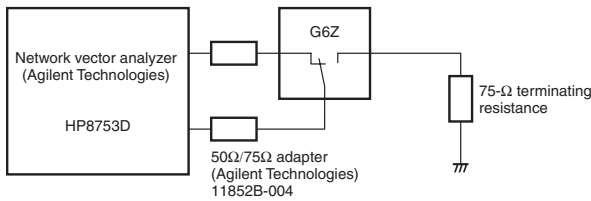

Through-hole Substrate (75-Ω Models, E-shape or Y-shape)

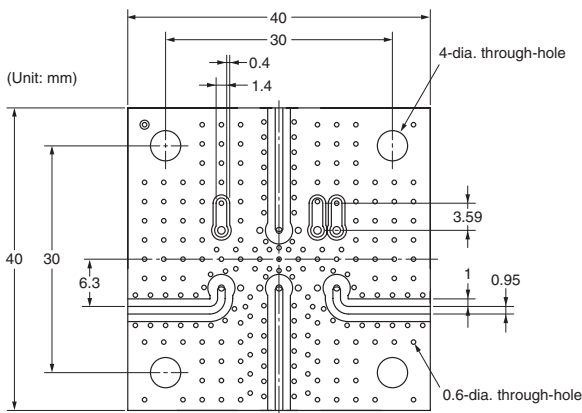

SMD-type Substrate (75-Ω Models, E-shape or Y-shape)

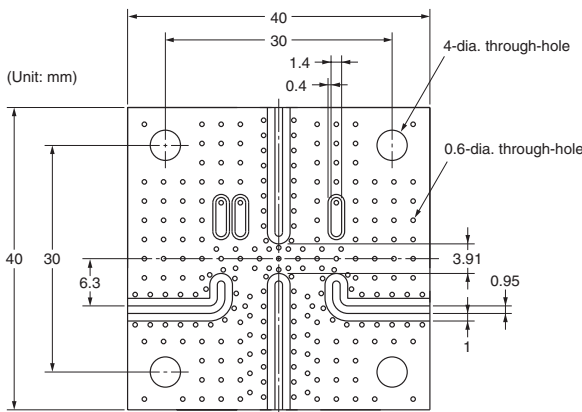

Substrate for High-frequency Characteristic Compensation (75-Ω Models, E-shape or Y-shape)

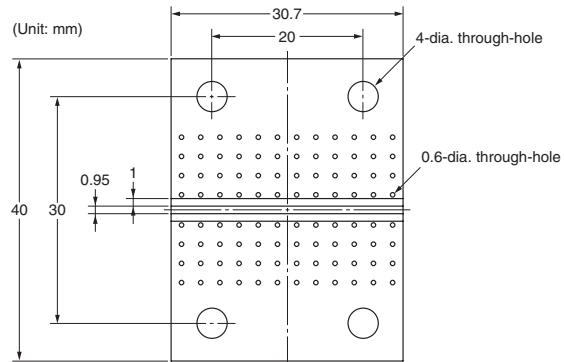

Substrate Types

Material: FR-4 glass epoxy (glass cloth impregnated with epoxy resin and copper laminated to its outer surface)

Thickness: 1.6 mm

Thickness of copper plating: 18 μm

- Note:**
1. The compensation substrate is used when measuring the Relay's insertion loss. The insertion loss is obtained by subtracting the measured value for the compensation substrate from the measured value with the Relay mounted to the high-frequency measurement substrate.
 2. For convenience, the diagrams of the high-frequency measurement substrates given here apply both to models with an E-shape terminal structure and to models with a Y-shape terminal structure.
 3. Be sure to mount a standoff tightly to the through-hole substrate.
 4. Use measuring devices, connectors, and substrates that are appropriate for 50 Ω and 75 Ω respectively.
 5. Ensure that there is no pattern under the Relay. Otherwise, the impedance may be adversely affected and the Relay may not be able to attain its full characteristics.

Handling

Do not use the Relay if it has been dropped. Dropping the Relay may adversely affect its functionality.

Protect the Relay from direct sunlight and keep the Relay under normal temperature, humidity, and pressure.

Flow Soldering

Solder: JIS Z3282, H63A

Soldering temperature: Approx. 250°C (260°C if the DWS method is used)

Soldering time: Approx. 5 s max. (approx. 2 s for the first time and approx. 3 s for the second time if the DWS method is used)

Be sure to make a molten solder level adjustment so that the solder will not overflow on the PCB.

Claw Securing Force During Automatic Mounting

During automatic insertion of Relays, be sure to set the securing force of each claw to the following so that the Relay's characteristics will be maintained.

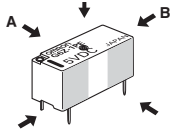

Direction A: 4.90 N max.
Direction B: 4.90 N max.
Direction C: 4.90 N max.

Secure the claws to the shaded area.
Do not attach them to the center area
or to only part of the Relay.

Latching Relay Mounting

Make sure that the vibration or shock that is generated from other devices, such as Relays, on the same panel or substrate and imposed on the Latching Relay does not exceed the rated value, otherwise the set/reset status of the Latching Relay may be changed. The Latching Relay is reset before shipping. If excessive vibration or shock is imposed, however, the Latching Relay may be set accidentally. Be sure to apply a reset signal before use.

Coating

Do not use silicone coating to coat the Relay when it is mounted to the PCB. Do not wash the PCB after the Relay is mounted using detergent containing silicone. Otherwise, the detergent may remain on the surface of the Relay.

Omron Electronic Components, LLC

Terms and Conditions of Sales

I. GENERAL

1. **Definitions:** The words used herein are defined as follows.
 - (a) **Terms:** These terms and conditions
 - (b) **Seller:** Omron Electronic Components LLC and its subsidiaries
 - (c) **Buyer:** The buyer of Products, including any end user in section III through VI
 - (d) **Products:** Products and/or services of Seller
 - (e) **Including:** Including without limitation
2. **Offer; Acceptance:** These Terms are deemed part of all quotations, acknowledgments, invoices, purchase orders and other documents, whether electronic or in writing, relating to the sale of Products by Seller. Seller hereby objects to any Terms proposed in Buyer's purchase order or other documents which are inconsistent with, or in addition to, these Terms.
3. **Distributor:** Any distributor shall inform its customer of the contents after and including section III of these Terms.

II. SALES

1. **Prices; Payment:** All prices stated are current, subject to change without notice by Seller. Buyer agrees to pay the price in effect at time of shipment. Payments for Products received are due net 30 days unless otherwise stated in the invoice. Buyer shall have no right to set off any amounts against the amount owing in respect of this invoice.
2. **Discounts:** Cash discounts, if any, will apply only on the net amount of invoices sent to Buyer after deducting transportation charges, taxes and duties, and will be allowed only if (a) the invoice is paid according to Seller's payment terms and (b) Buyer has no past due amounts owing to Seller.
3. **Interest:** Seller, at its option, may charge Buyer 1.5% interest per month or the maximum legal rate, whichever is less, on any balance not paid within the stated terms.
4. **Orders:** Seller will accept no order less than 200 U.S. dollars net billing.
5. **Currencies:** If the prices quoted herein are in a currency other than U.S. dollars, Buyer shall make remittance to Seller at the then current exchange rate most favorable to Seller; provided that if remittance is not made when due, Buyer will convert the amount to U.S. dollars at the then current exchange rate most favorable to Seller available during the period between the due date and the date remittance is actually made.
6. **Governmental Approvals:** Buyer shall be responsible for all costs involved in obtaining any government approvals regarding the importation or sale of the Products.
7. **Taxes:** All taxes, duties and other governmental charges (other than general real property and income taxes), including any interest or penalties thereon, imposed directly or indirectly on Seller or required to be collected directly or indirectly by Seller for the manufacture, production, sale, delivery, importation, consumption or use of the Products sold hereunder (including customs duties and sales, excise, use, turnover and license taxes) shall be charged to and remitted by Buyer to Seller.
8. **Financial:** If the financial position of Buyer at any time becomes unsatisfactory to Seller, Seller reserves the right to stop shipments or require satisfactory security or payment in advance. If Buyer fails to make payment or otherwise comply with these Terms or any related agreement, Seller may (without liability and in addition to other remedies) cancel any unshipped portion of Products sold hereunder and stop any Products in transit until Buyer pays all amounts, including amounts payable hereunder, whether or not then due, which are owing to it by Buyer. Buyer shall in any event remain liable for all unpaid accounts.
9. **Cancellation; Etc:** Orders are not subject to rescheduling or cancellation unless Buyer indemnifies Seller fully against all costs or expenses arising in connection therewith.
10. **Force Majeure:** Seller shall not be liable for any delay or failure in delivery resulting from causes beyond its control, including earthquakes, fires, floods, strikes or other labor disputes, shortage of labor or materials, accidents to machinery, acts of sabotage, riots, delay in or lack of transportation or the requirements of any government authority.
11. **Shipping; Delivery:** Unless otherwise expressly agreed in writing by Seller:
 - (a) All sales and shipments of Products shall be FOB shipping point (unless otherwise stated in writing by Seller), at which point title to and all risk of loss of the Products shall pass from Seller to Buyer, provided that Seller shall retain a security interest in the Products until the full purchase price is paid by Buyer;
 - (b) Delivery and shipping dates are estimates only; and
 - (c) Seller will package Products as it deems proper for protection against normal handling and extra charges apply to special conditions.
12. **Claims:** Any claim by Buyer against Seller for shortage or damage to the Products occurring before delivery to the carrier must be presented in detail in writing to Seller within 30 days of receipt of shipment.

III. PRECAUTIONS

1. **Suitability:** IT IS THE BUYER'S SOLE RESPONSIBILITY TO ENSURE THAT ANY OMRON PRODUCT IS FIT AND SUFFICIENT FOR USE IN A MOTORIZED VEHICLE APPLICATION. BUYER SHALL BE SOLELY RESPONSIBLE FOR DETERMINING APPROPRIATENESS OF THE PARTICULAR PRODUCT WITH RESPECT TO THE BUYER'S APPLICATION INCLUDING (A) ELECTRICAL OR ELECTRONIC COMPONENTS, (B) CIRCUITS, (C) SYSTEM ASSEMBLIES, (D) END PRODUCT, (E) SYSTEM, (F) MATERIALS OR SUBSTANCES OR (G) OPERATING ENVIRONMENT. Buyer acknowledges that it alone has determined that the Products will meet their requirements of the intended use in all cases. Buyer must know and observe all prohibitions of use applicable to the Product/s.
2. **Use with Attention:** The followings are some examples of applications for which particular attention must be given. This is not intended to be an exhaustive list of all possible use of any Product, nor to imply that any use listed may be suitable for any Product:
 - (a) Outdoor use, use involving potential chemical contamination or electrical interference.
 - (b) Use in consumer Products or any use in significant quantities.

- (c) Energy control systems, combustion systems, railroad systems, aviation medical equipment, amusement machines, vehicles, safety equipment, installations subject to separate industry or government regulations.
- (d) Systems, machines, and equipment that could present a risk to life or property.
3. **Prohibited Use:** NEVER USE THE PRODUCT FOR AN APPLICATION INVOLVING SERIOUS RISK TO LIFE OR PROPERTY WITHOUT ENSURING THAT THE PRODUCT AS A WHOLE HAS BEEN DESIGNED TO ADDRESS THE RISKS, AND THE PRODUCT IS PROPERLY RATED AND INSTALLED FOR THE INTENDED PURPOSE WITHIN THE OVERALL EQUIPMENT OR SYSTEM.
4. **Motorized Vehicle Application:** USE OF ANY PRODUCT/S FOR A MOTORIZED VEHICLE APPLICATION MUST BE EXPRESSLY STATED IN THE SPECIFIC SELLER.
5. **Programmable Products:** Seller shall not be responsible for the Buyer's purchase of a programmable Product.

IV. WARRANTY AND LIMITATION

1. **Warranty:** Seller's exclusive warranty is that the Products will be free from defects in materials and workmanship for a period of twelve months from the date of sale (or such other period expressed in writing by Seller). SELLER MAKES NO WARRANTY, REPRESENTATION, EXPRESS OR IMPLIED, ABOUT ALL OTHER MATTERS INCLUDING NON-INFRINGEMENT, MERCHANTABILITY OR FITNESS FOR A PARTICULAR PURPOSE OF THE PRODUCTS.
2. **Buyer Remedy:** Seller's sole obligation hereunder shall be to replace (in the event of a non-complying Product or, at Seller's election, to repair or credit amount equal to the purchase price of the Product; provided that there shall be no liability for Seller or its affiliates unless Seller's analysis confirms that the Product is handled, stored, installed and maintained and not subject to contamination, misuse or inappropriate modification. Return of any Products by Buyer must be approved in writing by Seller before shipment.
3. **Limitation on Liability:** SELLER AND ITS AFFILIATES SHALL NOT BE LIABLE FOR SPECIAL, INDIRECT, INCIDENTAL OR CONSEQUENTIAL DAMAGES, INCLUDING PROFITS OR PRODUCTION OR COMMERCIAL LOSS IN ANY WAY CONNECTION WITH THE PRODUCTS, WHETHER SUCH CLAIM IS BASED IN CONTRACT, WARRANTY, NEGLIGENCE OR STRICT LIABILITY. FURTHER, IN NO EVENT SHALL THE LIABILITY OF SELLER OR ITS AFFILIATES EXCEED THE INDIVIDUAL PURCHASE PRICE OF THE PRODUCT ON WHICH LIABILITY IS ASSERTED.
4. **Indemnities:** Buyer shall indemnify and hold harmless Seller, its affiliates and employees from and against all liabilities, losses, claims, costs and expense (including attorney's fees and expenses) related to any claim, investigation, litigation or proceeding (whether or not Seller is a party) which arises or is alleged to arise from Buyer's omissions under these Terms or in any way with respect to the Products.

V. INFORMATION; ETC.

1. **Intellectual Property:** The intellectual property embodied in the Products is the property of Seller and its affiliates and Buyer shall not attempt to duplicate it without the written permission of Seller. Buyer (at its own expense) shall hold harmless Seller and defend or settle any action brought against Seller in which that it is based on a claim that any Product made to Buyer specifications infringes intellectual property rights of another party.
2. **Property; Confidentiality:** Notwithstanding any charges to Buyer for engineering, tooling, all engineering and tooling shall remain the exclusive property of Seller. Information and materials supplied by Seller to Buyer relating to the Product are confidential and proprietary, and Buyer shall limit distribution thereof to its employees and strictly prevent disclosure to any third party.
3. **Performance Data:** Performance data is provided as a guide in determining and does not constitute a warranty. It may represent the result of Seller's tests and the users must correlate it to actual application requirements.
4. **Change In Specifications:** Product specifications and description may be changed without any notice based on improvements or other reasons. It is Seller's practice to characterize numbers when published ratings or features are changed, or when significant engineering changes are made. However, some specifications of the Product may be changed without any notice.
5. **Errors And Omissions:** The information on Seller's website or in other documents has been carefully checked and is believed to be accurate; however, no responsibility is assumed for clerical, typographical or proofreading errors or omissions.
6. **Export Controls:** Buyer shall comply with all applicable laws, regulations and orders regarding (a) export of the Products or information provided by Seller; (b) sale of Products to forbidden or other proscribed persons or organizations; (c) disclosure of regulated technology or information.

VI. MISCELLANEOUS

1. **Waiver:** No failure or delay by Seller in exercising any right and no course of dealing between Buyer and Seller shall operate as a waiver of rights by Seller.
2. **Assignment:** Buyer may not assign its rights hereunder without Seller's written consent.
3. **Law:** These Terms are governed by Illinois law (without regard to conflict of laws) and state courts in Illinois have exclusive jurisdiction for any dispute hereunder.
4. **Amendment:** These Terms constitute the entire agreement between Buyer and Seller relating to the Products, and no provision may be changed or waived unless signed by the parties.
5. **Severability:** If any provision hereof is rendered ineffective or invalid, such provision shall not invalidate any other provision.

Certain Precautions on Specifications and Use

1. **Suitability for Use.** Seller shall not be responsible for conformity with any standards, codes or regulations which apply to the combination of the Product in Buyer's application or use of the Product. At Buyer's request, Seller will provide applicable third party certification documents identifying ratings and limitations of use which apply to the Product. This information by itself is not sufficient for a complete determination of the suitability of the Product in combination with the end product, machine, system, or other application or use. Buyer shall be solely responsible for determining appropriateness of the particular Product with respect to Buyer's application, product or system. Buyer shall take application responsibility in all cases but the following is a non-exhaustive list of applications for which particular attention must be given:
 - (i) Outdoor use, uses involving potential chemical contamination or electrical interference, or conditions or uses not described in this document.
 - (ii) Energy control systems, combustion systems, railroad systems, aviation systems, medical equipment, amusement machines, vehicles, safety equipment, and installations subject to separate industry or government regulations.
 - (iii) Use in consumer products or any use in significant quantities.
 - (iv) Systems, machines and equipment that could present a risk to life or property. Please know and observe all prohibitions of use applicable to this product.

NEVER USE THE PRODUCT FOR AN APPLICATION INVOLVING SERIOUS RISK TO LIFE OR PROPERTY WITHOUT ENSURING THAT THE SYSTEM AS A WHOLE HAS BEEN DESIGNED TO ADDRESS THE RISKS, AND THAT THE OMRON PRODUCT IS PROPERLY RATED AND INSTALLED FOR THE INTENDED USE WITHIN THE OVERALL EQUIPMENT OR SYSTEM.
2. **Programmable Products.** Seller shall not be responsible for the user's programming of a programmable product, or any consequence thereof.
3. **Performance Data.** Performance data given in this publication is provided as a guide for the user in determining suitability and does not constitute a warranty. It may represent the result of Seller's test conditions, and the users must correlate it to actual application requirements. Actual performance is subject to Seller's Warranty and Limitations of Liability.
4. **Change in Specifications.** Product specifications and accessories may be changed at any time based on improvements and other reasons. It is our practice to change part numbers when published ratings or features are changed, or when significant construction changes are made. However, some specifications of the Product may be changed without any notice. When in doubt, special part numbers may be assigned to fix or establish key specifications for your application. Please consult with your Seller representative at any time to confirm actual specifications of purchased Product.
5. **Errors and Omissions.** The information in this publication has been carefully checked and is believed to be accurate; however, no responsibility is assumed for clerical, typographical or proofreading errors, or omissions.
6. **RoHS Compliance.** Where indicated, our products currently comply, to the best of our knowledge as of the date of this publication, with the requirements of the European Union's Directive on the Restriction of certain Hazardous Substances ("RoHS"), although the requirements of RoHS do not take effect until July 2006. These requirements may be subject to change. Please consult our website for current information.

Complete "Terms and Conditions of Sale" for product purchase and use are on Omron's website at <http://www.components.omron.com> – under the "About Us" tab, in the Legal Matters section.

ALL DIMENSIONS SHOWN ARE IN MILLIMETERS.

To convert millimeters into inches, multiply by 0.03937. To convert grams into ounces, multiply by 0.03527.

OMRON®

**OMRON ELECTRONIC
COMPONENTS LLC**

55 E. Commerce Drive, Suite B
Schaumburg, IL 60173

847-882-2288

OMRON ON-LINE

Global - <http://www.omron.com>

USA - <http://www.components.omron.com>